



Die Kompetenzmarke für Energiesparsysteme

Montageanleitung

Befestigungsset Regelung GKS

Inhaltsverzeichnis

5W - Regelung.....3-6



3W / 4W - Regelung8-11



Supramat12-15

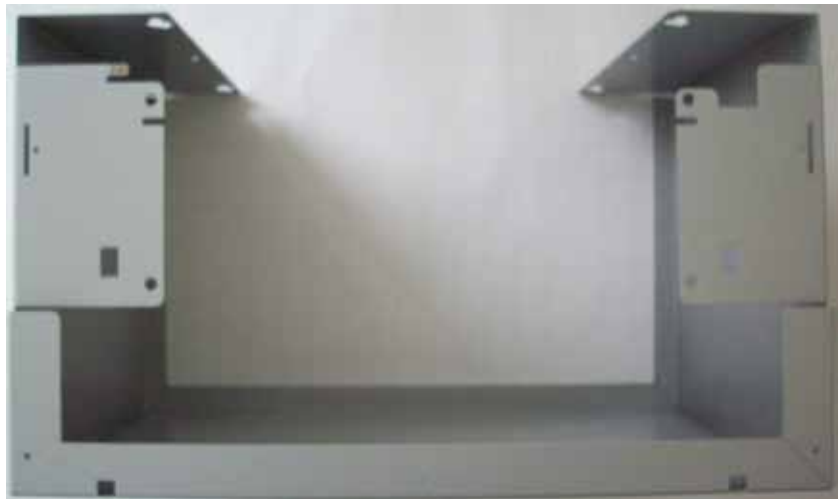

**1.****2.****2 x****+**

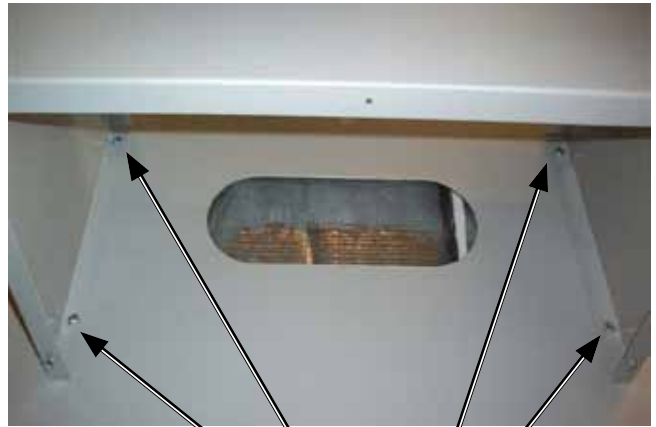
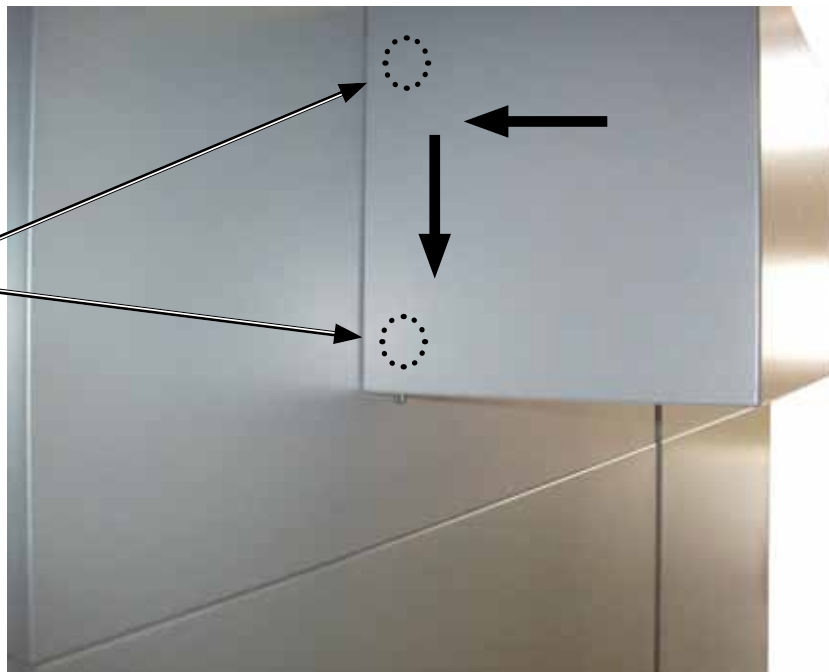
3.**Eurotwin****4 x****Dynatherm****4 x****4.**

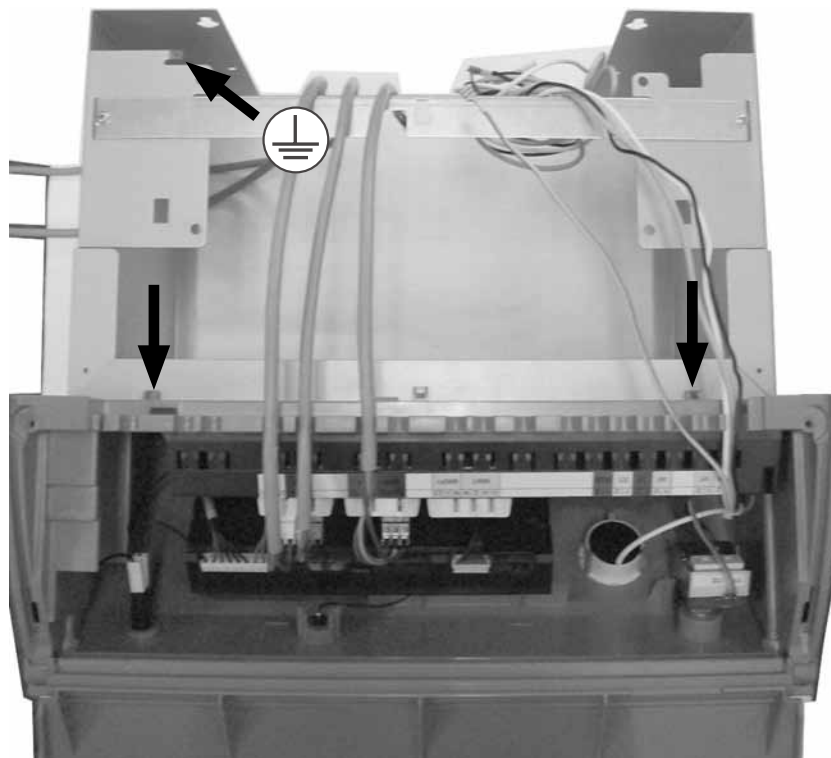
5.**2 x****6.**

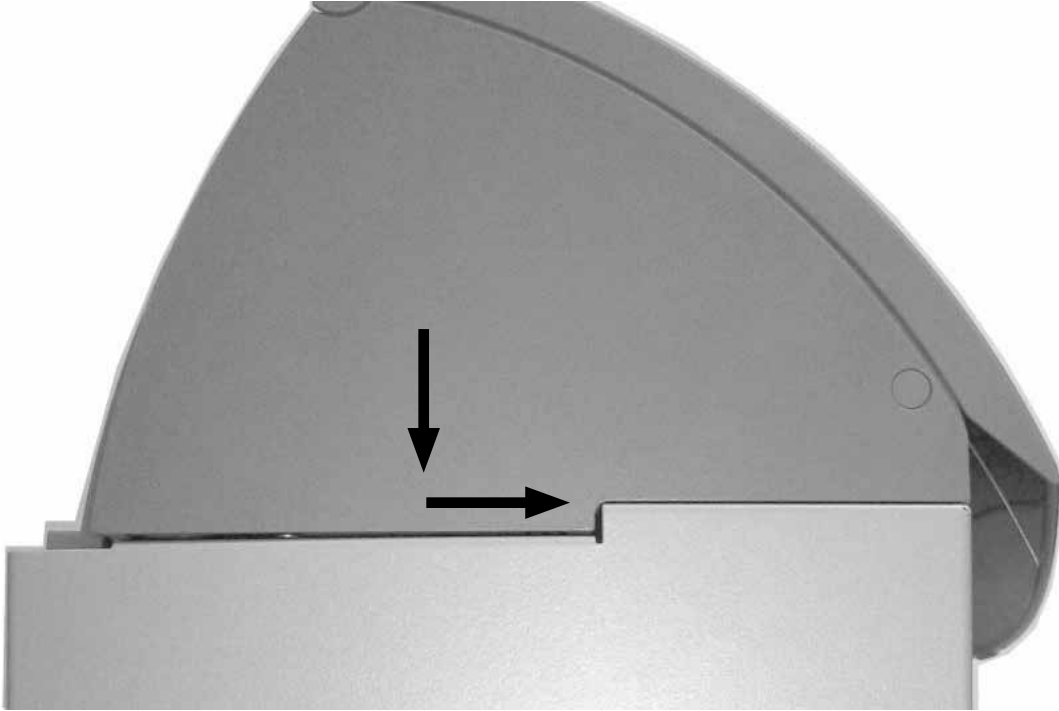
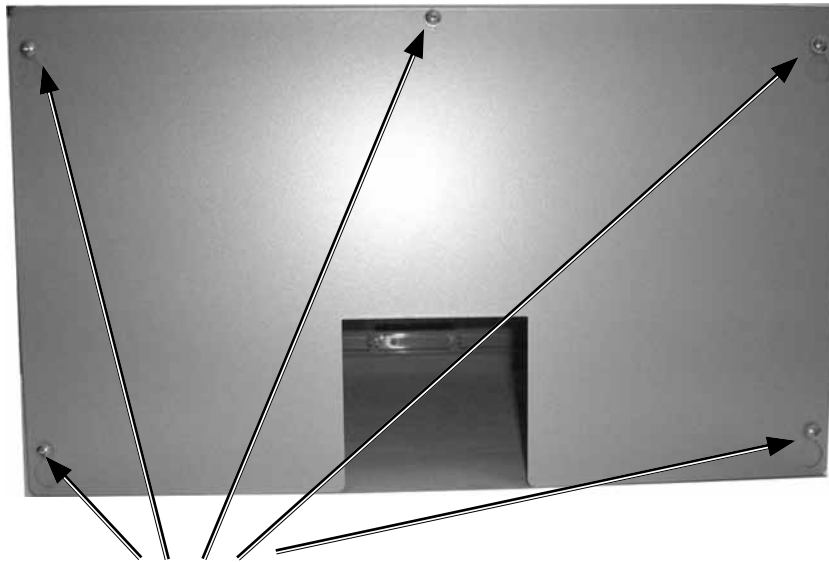
7.**8.****5 x****+**

**Demontage
Disassembly
Démontage**

drücken
push
presser

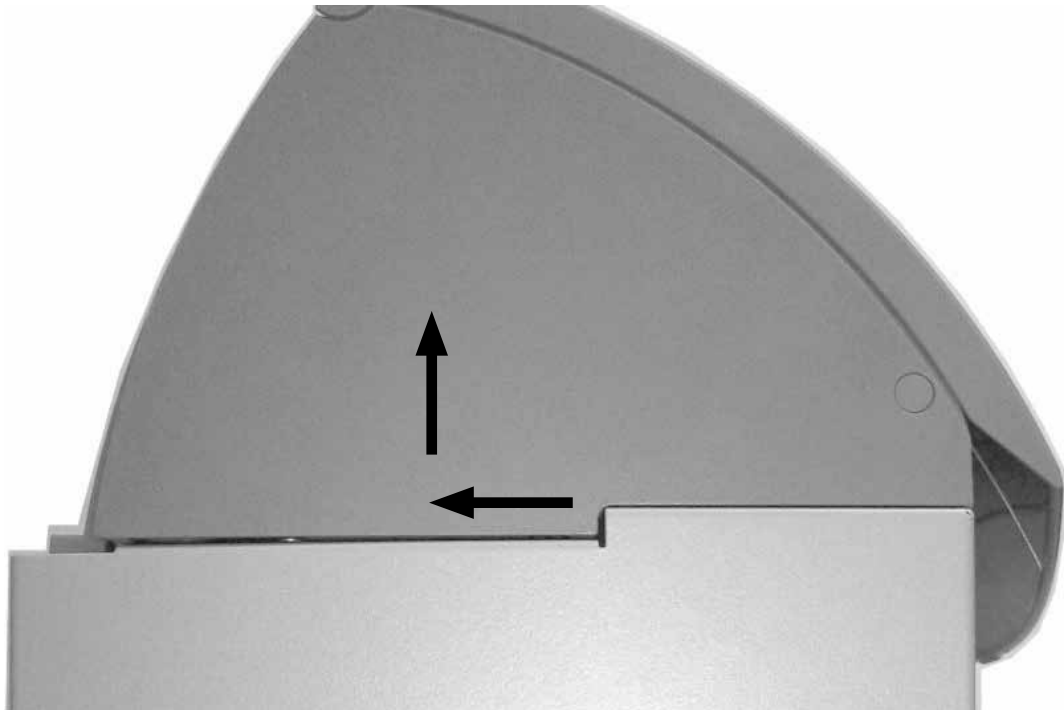
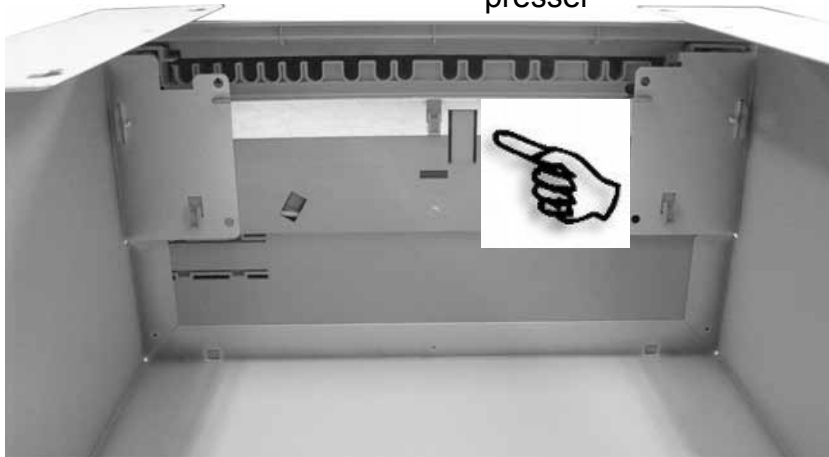



1.

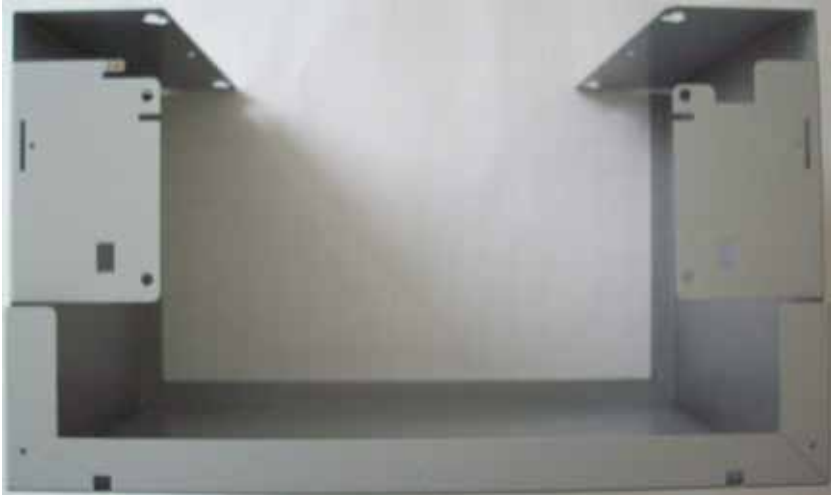

2.



3 x



+



3.

4 x



+

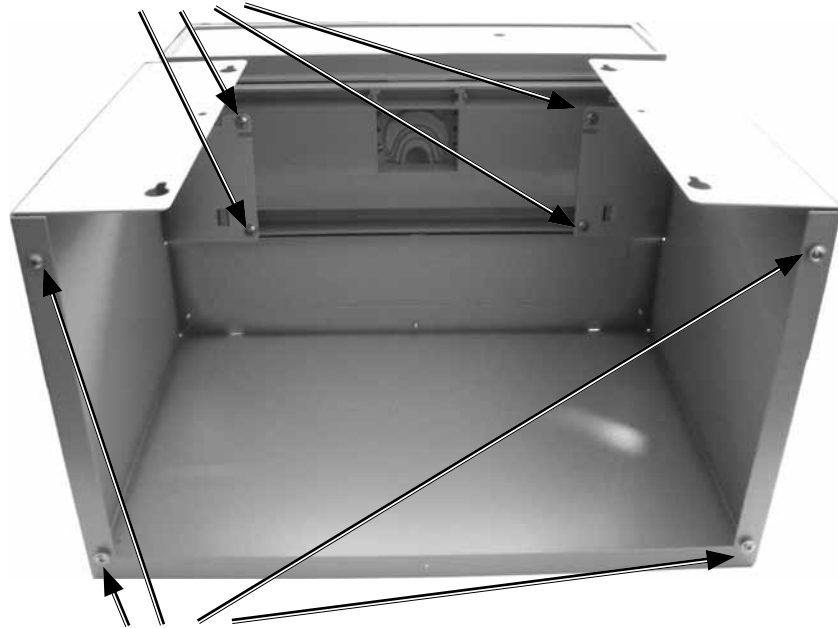

4 x



+



4.

Eurotwin



4 x

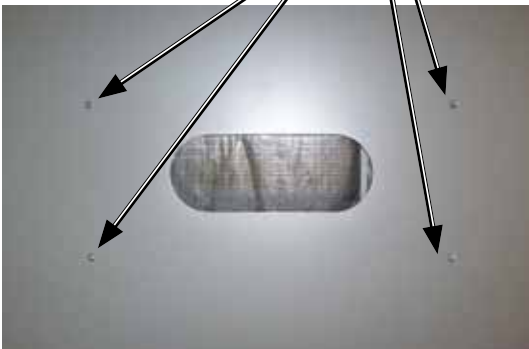

Dynatherm



4 x

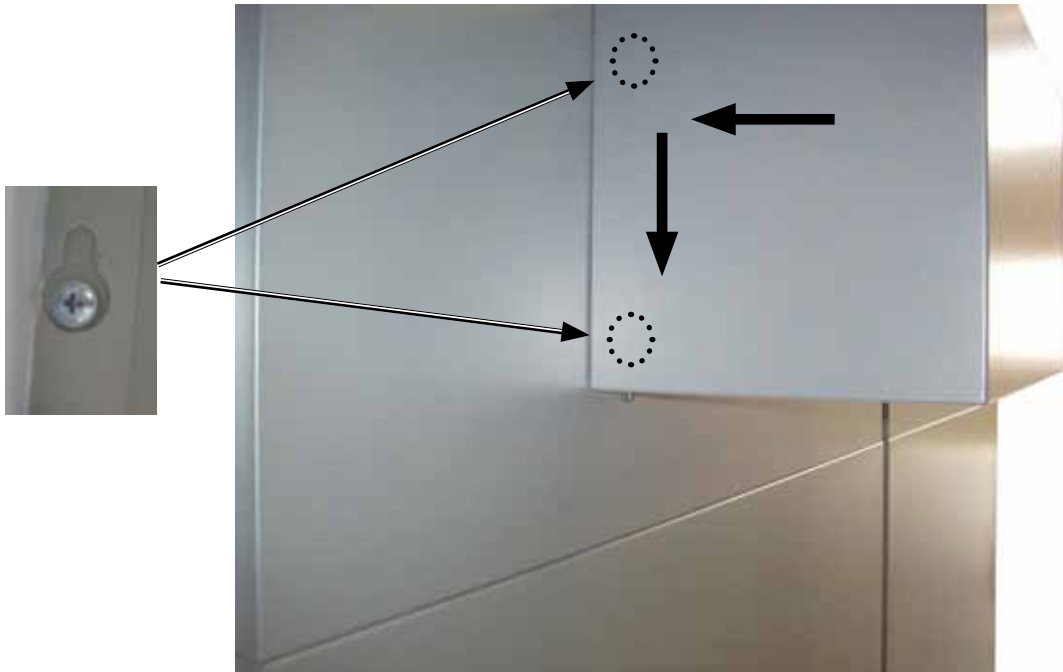

5.**6.****2 x**

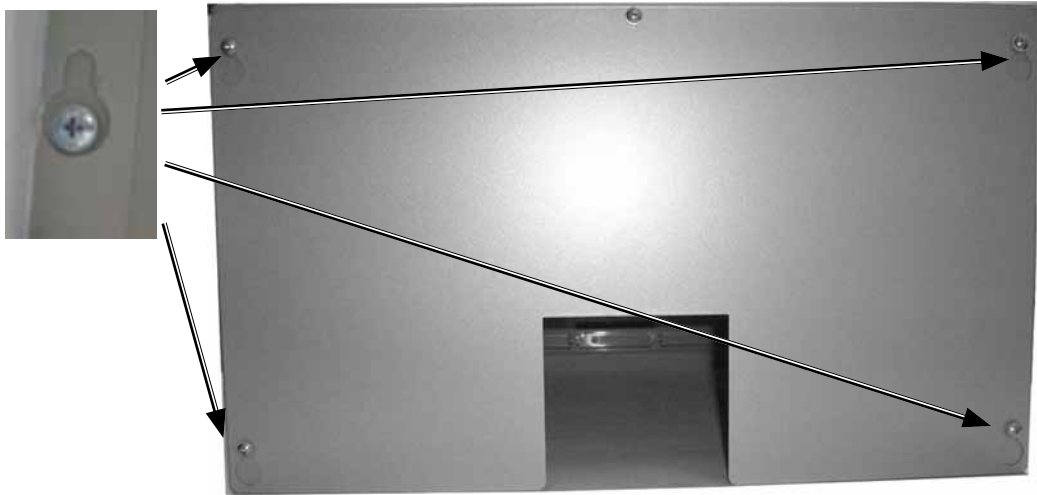
7.**1 x****+**



1.



2.

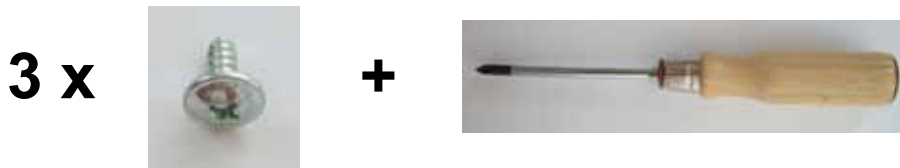
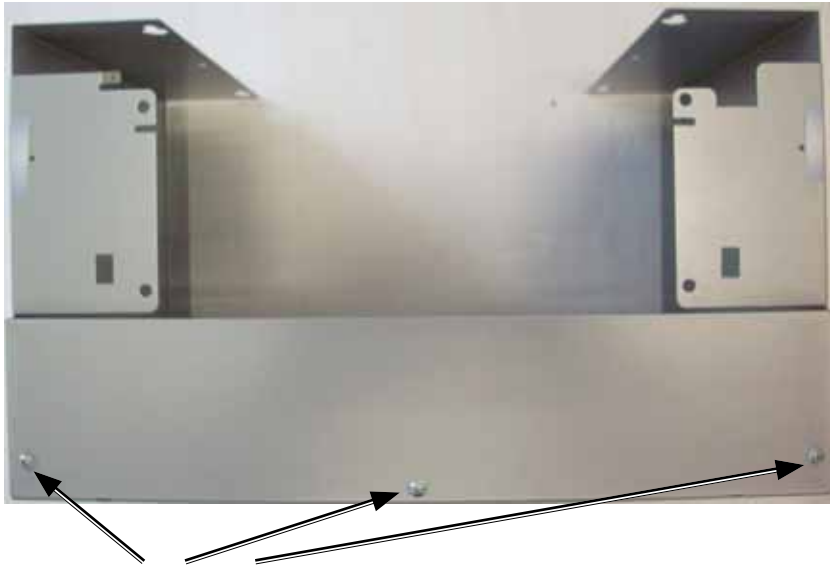

3.



4.

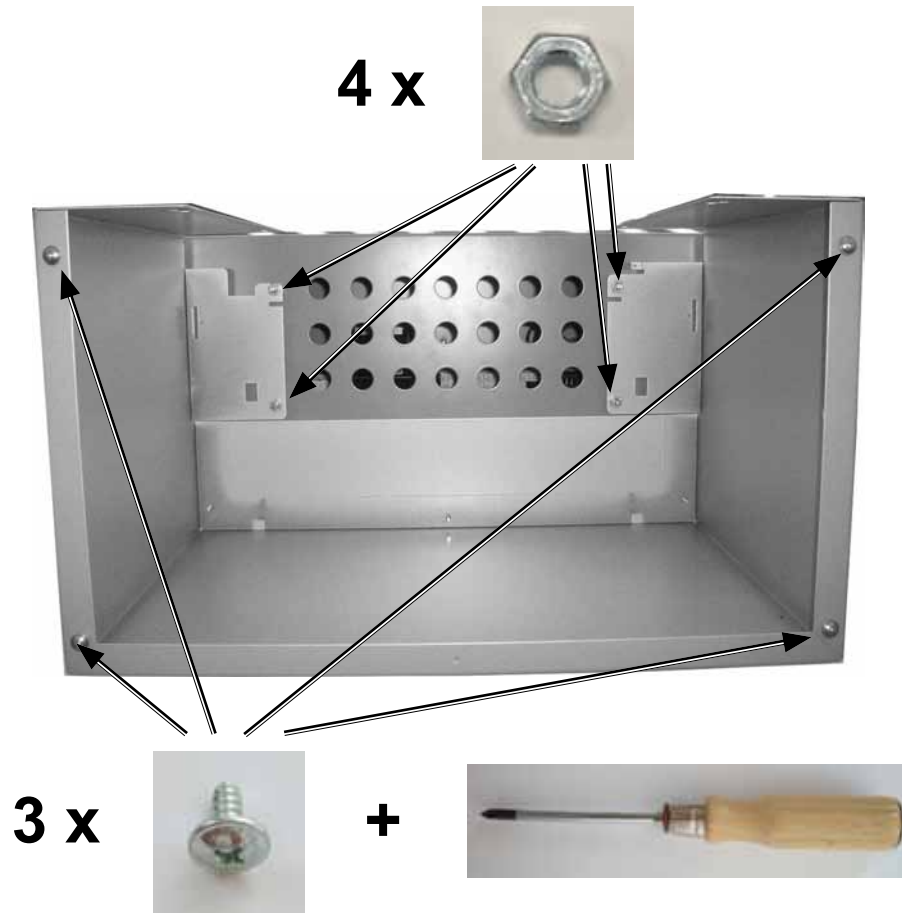

5.

Eurotwin



4 x

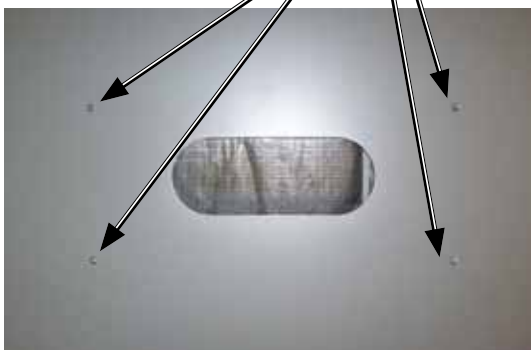

Dynatherm



4 x

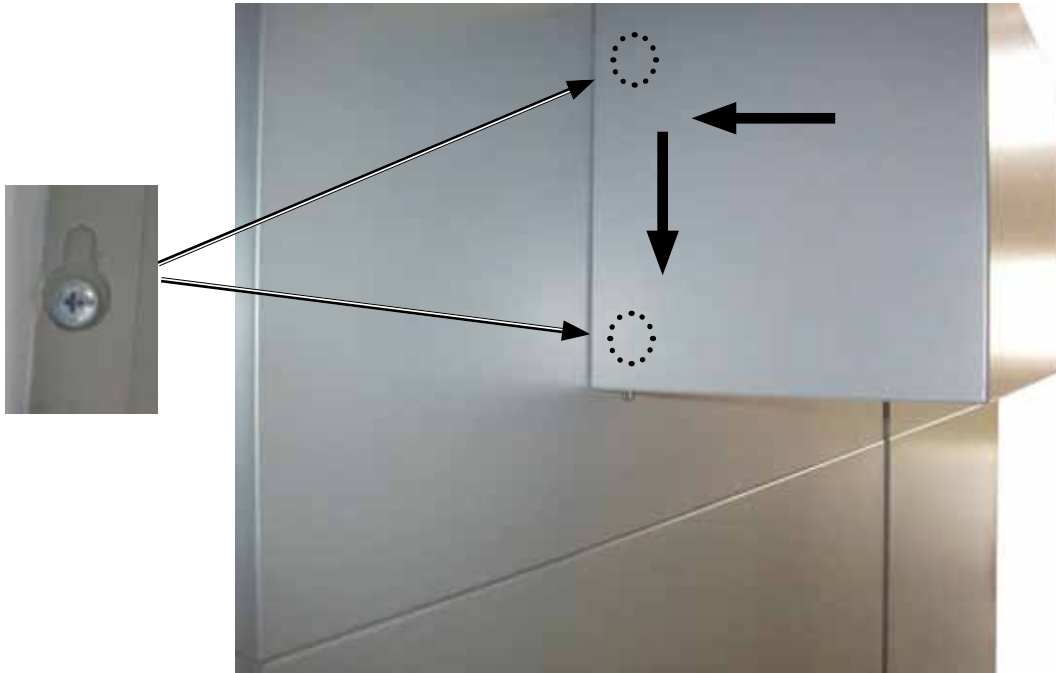

6.**7.****2 x**

8.