



Die Kompetenzmarke für Energiesparsysteme

**D** **Montageanleitung**  
**Ausdehnungsgefäß CS**

Seite 2

**FR** **Instructions de montage**  
**Vase d'expansion CS**

pages 3

**BE** **Montageaanwijzingen**  
**Aansluitset COB met CS**

**NL** Pagina 4

**ES** **Instrucciones de montaje**  
**Vaso de expansión CS**

Página 5

**DK** **Monteringsvejledning**  
**Trykekspressionsbeholder CS**

Side 6

**Lieferumfang:**

**Ausdehnungsgefäß CS**  
bestehend aus:

Pos.	Stück	Benennung
1	1	Ausdehnungsgefäß Trinkwasser 8 Liter 10 bar
2	1	Verrohrung KW-Anschluß auf AD Gefäß CS
3	2	Fit.Doppelnippel G3/4" x R3/4" AG
4	2	Flachdichtung 24x17x2
5	1	T - Stück
6	1	Montageanleitung

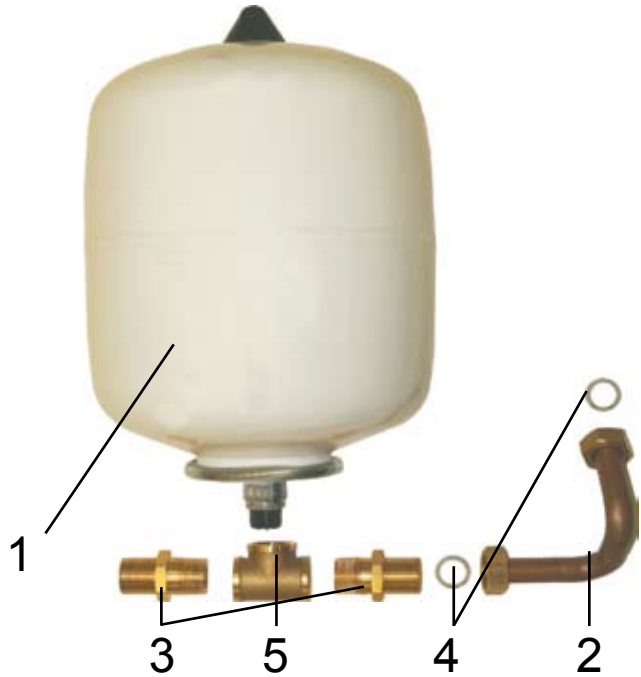

**Rückansicht CS**

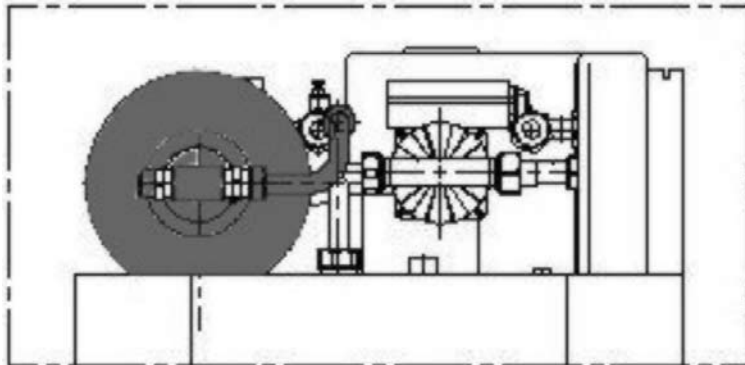

**Draufsicht CS**

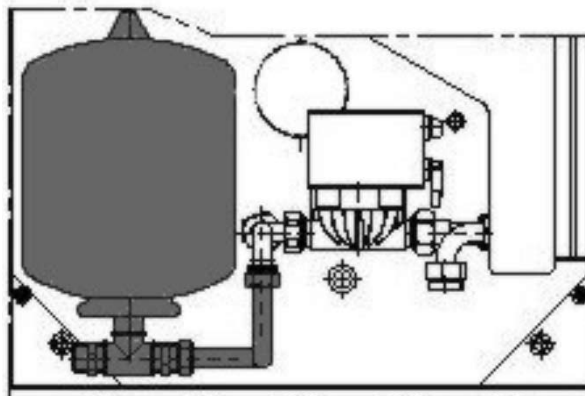

**Pièces fournies:****Vase d'expansion CS**

composé de:

Pos.	Quantité	Désignation
1	1	Vase d'expansion pour eau potable, 8 litres, 10 bars
2	1	Tuyauterie avec raccordement eau chaude / eau froide sur vase d'expansion CS
3	2	Embout double du raccord G3/4" x R3/4" filet ext.
4	2	Joint plat 24 x 17 x 2
5	1	Raccord en T
6	1	Instructions de montage

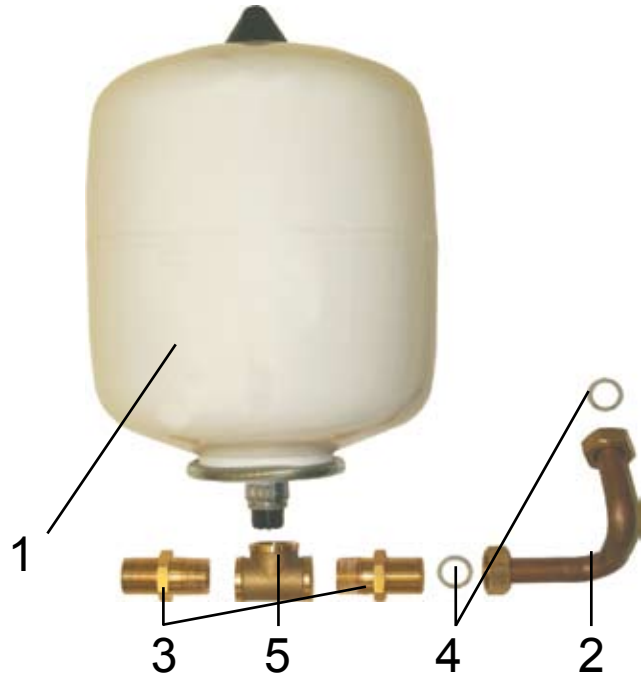
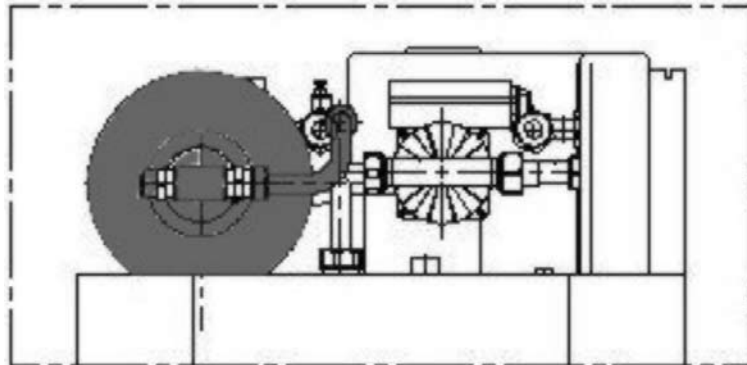
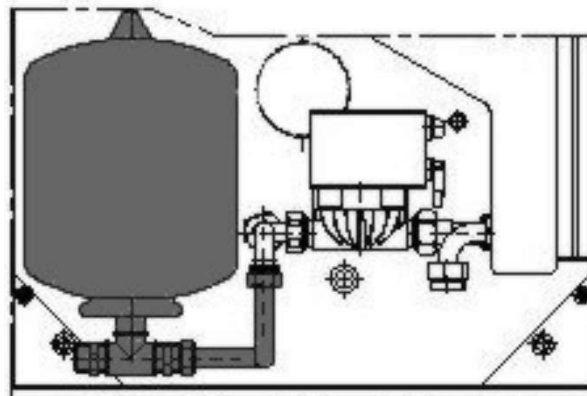
**Vue arrière CS****Vue de dessus CS**

**Leveringsomvang:**

**expansievat CS**

bestaat uit:

Pos.	Aantal	Benaming
1	1	Expansievat drinkwater 8 liter 10 bar
2	1	Buisleiding KW-aansluiting op exp vat CS
3	2	Fit.dubbele nippel G3/4" x R3/4" uitwendige schroefdraad
4	2	Vlakke dichting 24x17x2
5	1	T-stuk
6	1	Montageaanwijzingen

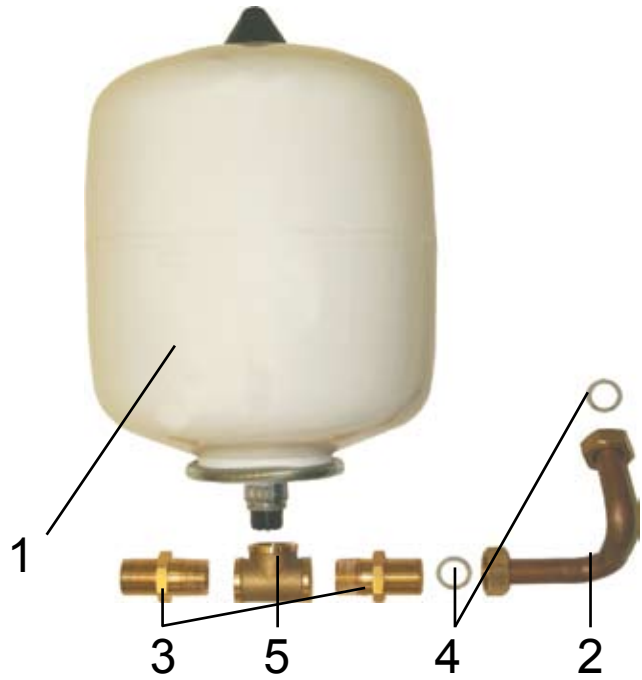

**Achteraanzicht CS**

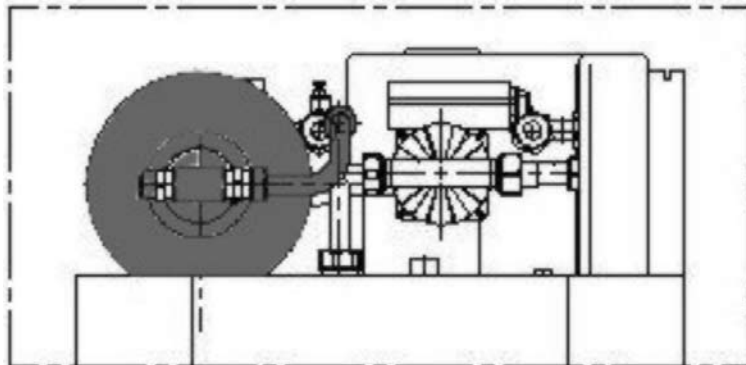

**Vooraanzicht CS**

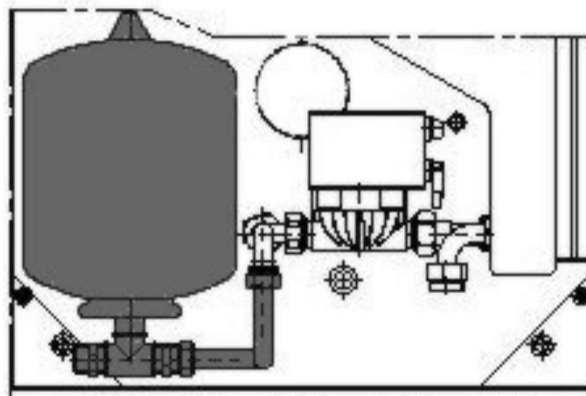

**Volumen de suministro:**

**Vaso de expansión CS**

compuesto de:

Pos.	Cantidad	Denominación
1	1	Vaso de expansión agua potable 8 litros 10 bar
2	1	Tubería conexión agua fría a vaso de expansión CS
3	2	Racor boquilla doble G3/4" x R3/4" RE
4	2	Junta plana 24x17x2
5	1	Pieza T
6	1	Instrucciones de montaje

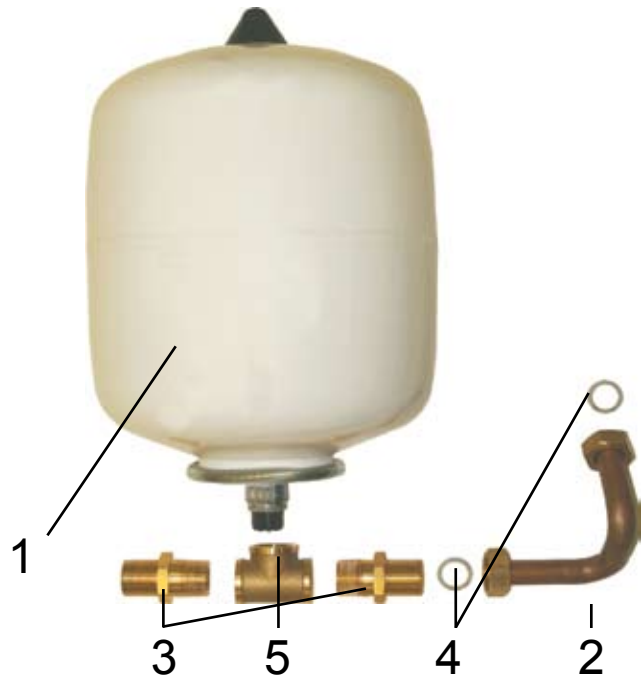

**Vista posterior CS**

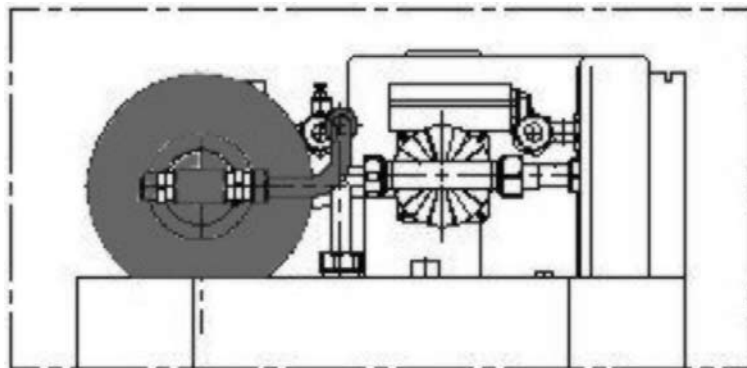

**Vista en planta CS**

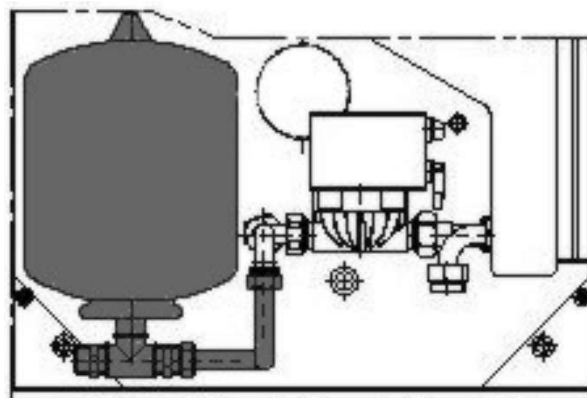

## Leveringsomfang:

### Trykspansionsbeholder CS

Bestående af:

Pos.	Antal	Beskrivelse
1	1	Trykspansionsbeholder for brugsvand 8 liter, 10 bar
2	1	Rørstykke for KV-tilslutning for ekspansionsbeholder til CS
3	2	Dobbelnippel G3/4" x R3/4"
4	2	Fiberpakning 24 x 17 x 2
5	1	Tee-stykke
6	1	Monteringsvejledning



### Set bagfra

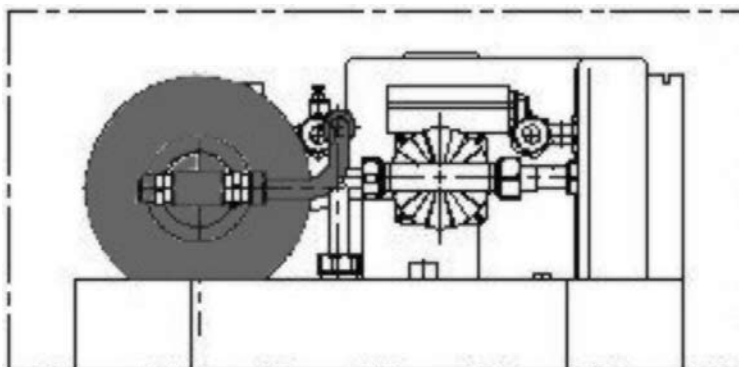

### Set ovenfra

